

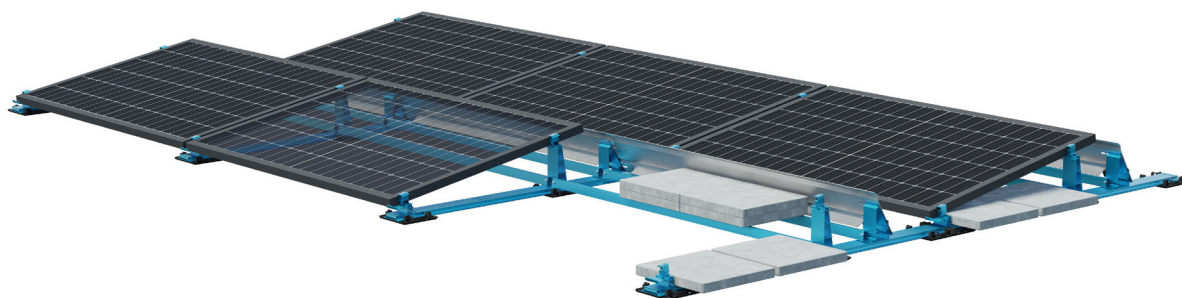

Assembly Instructions

LEICHTmount RAIL 2.1 S

Flat roof system for south-facing orientation



1 Introduction

1.1	Intended Use	3
1.2	About this document	3
1.3	Warnings	4
1.4	General information - standards and guidelines	4
1.5	Description of the system	6

2 Installation - LEICHTmount RAIL 2.1 S

2.1	System components	11
2.2	Installation - ground rail	12
2.3	Installation - tower and tower windshield	13
2.4	Installation - roll-bar adapter	14
2.5	Installation - roll-bar	15
2.6	Ballast	16
2.7	Optional roof fastening - assembly post	19
2.8	Module assembly	22
2.9	Windshield	26
2.10	Covering cable duct	27
2.11	Side panel	28
2.12	Final inspection	29

3 Disassembly and disposal

3.1	Disassembly	30
3.2	Disposal	30

4 Terms of use and warranty

4.1	User agreement LEICHTmount RAIL 2.1 S	31
4.2	Warranty/ disclaimer	31

Read these installation guidelines carefully before installing the S:FLEX mounting system and retain them for future reference!

These installation guidelines are only complete with the project-specific implementation plans (project report)!

1.1 Intended use

The S:FLEX LEICHTmount PV mounting system LEICHTmount RAIL 2.1 S is a frame system for mounting PV modules without roof penetration.

It is designed exclusively for the installation of PV modules.

The LEICHTmount RAIL 2.1 S is designed for the installation of east/west-facing systems with module pitch angles of 10° or 15°.

The system is configured for horizontal module installation.

The adjustable components allow the use of almost all commercially available modules.

The LEICHTmount RAIL 2.1 S system is designed for easy installation on the following substrates:

Foil roofs, bitumen roofs, gravel roofs, green roofs, concrete roofs.

Any other use in this regard is considered misuse of the product. In particular, compliance with the instructions in these installation guidelines constitutes intended use. S:FLEX GmbH accepts no liability for damage resulting from nonobservance of the installation guidelines or from misuse or incorrect use of the product.

1.2 About this document

This installation instruction describes the installation of the LEICHTmount RAIL 2.1 S system on flat roofs with a pitch angle of 10°.

It must be ensured that only the current and complete installation instructions are used for installation.

1.3 Warnings

The warning texts provided in these installation guidelines relay safety-related information. They are:



Unless observed, there is a major risk of injury as well as a risk of death.



Failure to observe this may lead to property damage.

1.4 General information – standards and guidelines

Every photovoltaic system must be installed in accordance with the instructions contained in the respective installation guidelines and the project report.

These installation instructions are based on state-of-the-art technology and many years of experience of installing our systems on site. It must be ensured that only the current and complete installation instructions are used for the installation, and that a print-out of the installation guidelines is stored in the immediate vicinity of the system. The system and these guidelines are subject to technical changes.

The project report is part of the installation instructions and is created on a project-specific basis. All of the information contained in the project report must be strictly observed. The project report contains the location-based static calculations. The S:FLEX mounting system must be designed and created with the S:FLEX software.

Since individual project-specific features must be considered with every roof, expert advice must always be sought prior to installation. Before installation, the PV system creator must ensure that the existing roofing and roof substructure are suitable for the additional loads. The condition of the roof substructure, the quality of the roof covering and the maximum load-bearing capacity of the roof construction must be checked by the system creator.

Contact a local structural engineer for this purpose.

When installing the PV system, always comply with the module manufacturer's installation instructions. In particular, it is necessary to check that the module manufacturer's instructions regarding the module clamping guidelines (module clamping surface and clamping range) are complied with. If this is not the case, the customer must obtain a declaration of consent from the module manufacturer before the installation; alternatively, the mounting system must be adapted in accordance with the module manufacturer's specifications.

The requirements for the protection of PV mounting systems against lightning and surges must be met in accordance with the DIN and VDE regulations. The specifications of the relevant power supply company must be observed.

Care must be taken that the PV system to be installed does not impair the functioning of the existing lightning protection system. It is also important to ensure that the PV system is designed so that it can be included in the protection zone of the building's lightning protection system. The separation distances between the PV system and the lightning protection system specified in the relevant regulations must be adhered to. During installation, the local fire regulations must be observed, e.g. firewalls must not be built over and the required clearances must be maintained.

If the roofing is altered, the manufacturer's guidelines must be observed. During and after installation, the frame components may not be stepped on or be used as a climbing aid. There is a risk of falling and the roofing underneath could be damaged.

Prior to installation, the creator of the photovoltaic system must ensure that the installation is carried out while strictly adhering to national and location-specific building regulations, safety and accident prevention regulations, standards and environmental protection regulations.

Every person who installs the S:FLEX PV mounting systems is obligated to independently inform himself/herself about all rules and regulations for professionally correct planning and installation, and to comply with said rules and regulations during the installation process. This also includes compliance with the latest versions of the respective rules and regulations.

Installation of the PV system may only be carried out by trained specialists.



All system components must be checked for damage before installation. Damaged components must not be used!



Installation of the S:FLEX substructure and the PV system may only be carried out by trained specialists. System components must not be used as step ladders. The modules must not be stepped on. When working on roofs, there is a risk of falling off and falling through roofs. A fall can result in injury or death. Ensure that appropriate climbing aids and fall-protection equipment (e.g. scaffolding) are provided as well as protection from falling parts.



Check the building statics and construction/condition of the roof substructure before starting the installation. During installation, the instructions in the installation guidelines and project report must be strictly observed. Failure to observe the installation guidelines and the project report may result in damage to the PV system and to the building.

1.5 Description of the system

The LEICHTmount RAIL 2.1 S system includes solutions to suit a range of different requirements:

System properties

Mounting angle:	the LEICHTmount 2.1 S is available with 10° and 15° mounting angles
Roof edge spacing:	Roof areas F and G can be used
Module dimensions:	S 10°: 1.550 – 2.340 mm x 985 – 1.300 mm (length x width) S 15°: 1.550 – 2.340 mm x 985 – 1.300 mm (length x width) The use of modules with deviating dimensions must be checked and approved for each project.
Max. roof pitch:	5°, up to 10° on request
Building height:	max. 35 m (greater building heights up to 50 m on request)
Wind load:	up to 2.4 KN/m ²
Snow load:	up to 5.4 KN/m ²
Modules:	The modules are fitted to the short side. Only solar modules with general approvals or project-related approvals from module manufacturers regarding the clamping to the short side may be used.
Materials:	extruded aluminium EN AW-6060 T66 and stainless steel A2-70
Prerequisites:	Proof of static load capacity of the roof and the roof insulation must be provided by customer. Our general terms and conditions, warranty conditions and the user agreement apply.



The module manufacturer's installation instructions must always be observed.

Flat-roof coverings

The LEICHTmount RAIL 2.1 S can be installed on the following flat roof coverings foil roof, bitumen roof, gravel roof, green roof, concrete roof.

The roof covering (and possible insulation layer) must be able to absorb the pressure loads of the PV system. For mineral wool as insulation material, the compressive strength must be at least 70kPa at 10% compression, a load-distributing layer must be arranged above the insulation and the manufacturer's approval must be available. The friction coefficient of the existing roof covering is the basis of the ballasting plan and must be determined by the customer.

For installation on gravelled roofs, a protective layer is prescribed between the water-bearing roof cladding and the gravel fill. The gravel fill must have a minimum depth of 50mm and a grain size of 16/32.



S:FLEX GmbH may provide a measuring device in order to determine the project-specific friction coefficient.

Row spacings

LEICHTmount RAIL 2.1 S 10°

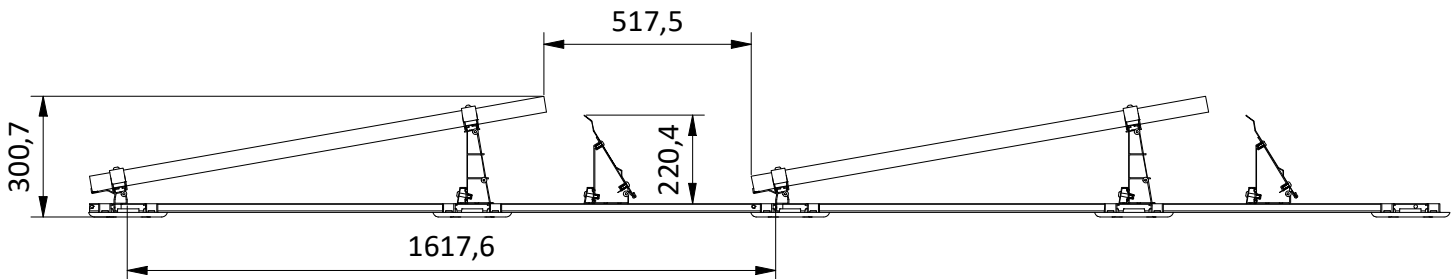

For better absorption and distribution of the pressure loads, the Ground rails are clicked together with base plates in accordance with the project report. The cladding variants using the example of the LmR 2.1 Ground rail type 1632.

Partial: 2 Base Plates - click system based on the mounting template

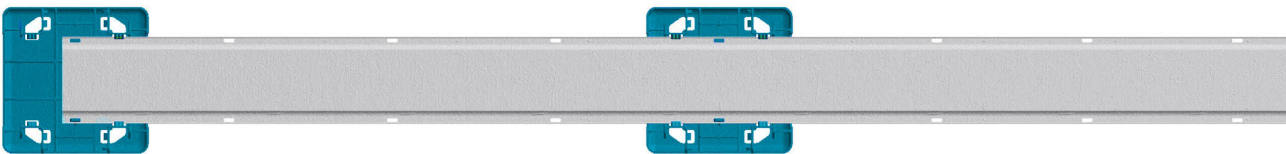

Partial: 4 Base Plates - click system based on the mounting template

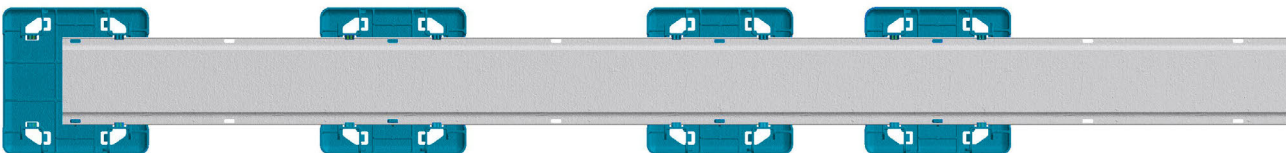

Partial: 7 Base Plates - click system based on the mounting template

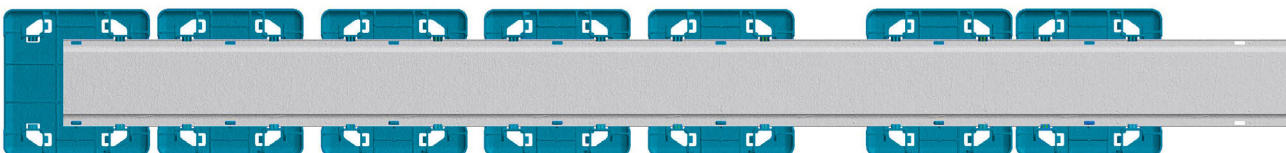

Full surface: 8 Base Plates - click system based on the mounting template



Installation note regarding module widths

The S:FLEX LEICHTmount RAIL 2.1 S 10° system is suitable for mounting modules with a width between 985 - 1.300 mm. Different brackets (base) are used for the modules.

Basic conditions for the module field size

The S:FLEX LEICHTmount RAIL 2.1 S system allows a variable module arrangement. This allows optimal utilisation of the roof area. In principle, the module layout should always be based on the module arrangement specified in the project report. The maximum size of the module array is 20 m x 20 m.

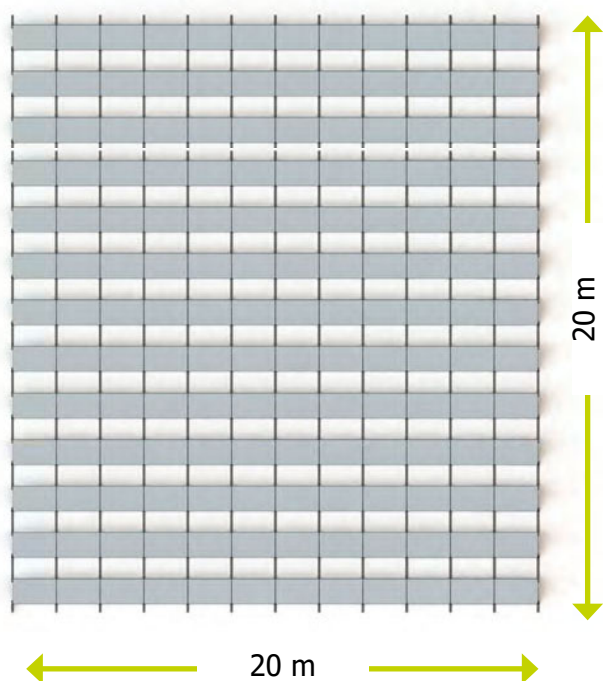

System design

LEICHTmount RAIL 2.1 S

The standard system is suitable for ordinary wind and snow loads. All values in the project report are design values as a load combination of dead weight, wind pressure and snow. These values are orientation values. The data from the project report are always decisive!

Therefore, check beforehand in which snow and wind load zone you want to use the system.

All components are available in different lengths and designs. The exact article designs can be found in the project documents.

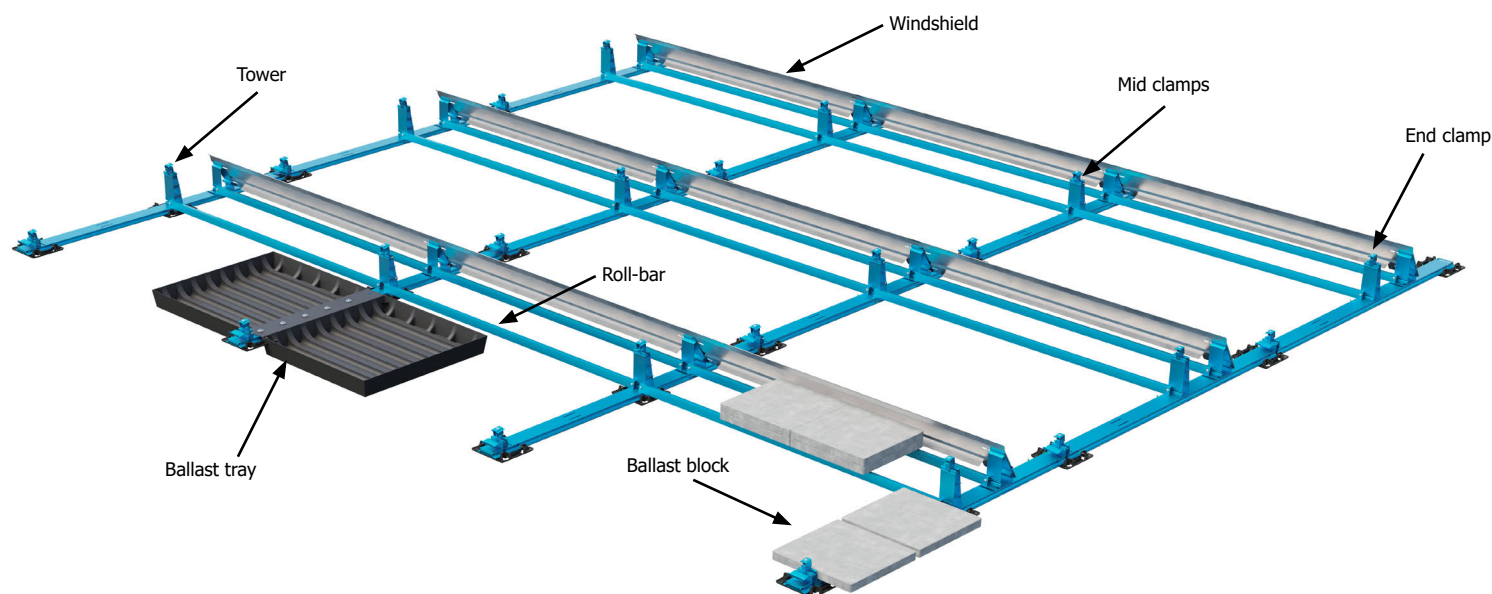
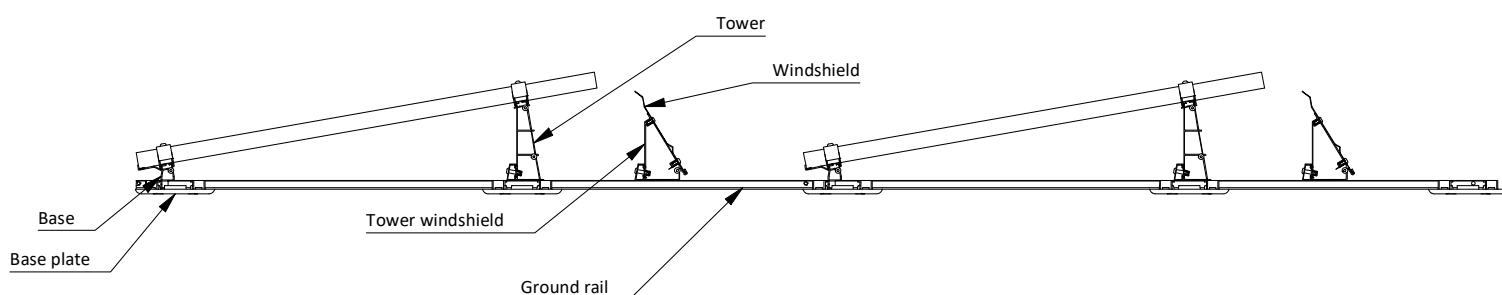

Earthing

Equipotential bonding between the individual system components must be ensured according to the respective countryspecific guidelines and standards. This installation instruction does not include an earthing concept and must be calculated or compiled by the executing installer in accordance with the applicable standards and guidelines.

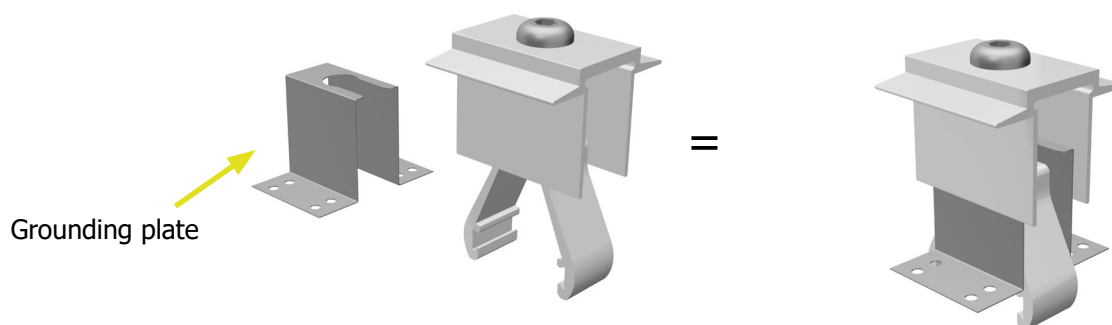

Module earthing via mid clamp with grounding plate

The requirements for the protection of PV mounting systems against lightning and surges must be met in accordance with the applicable regulations. The specifications of the responsible energy supply company must be observed. The LEICHTmount RAIL S mounting system is capable of carrying lightning current in accordance with DIN EN 62561-1: 2017-12 and can be integrated into the existing or planned lightning protection system.



The module manufacturer's installation instructions must always be observed.



The requirements for lightning and surge protection of mounting systems for PV systems must be met in accordance with the applicable regulations. The planning and execution of all lightning protection work may only be carried out by appropriately qualified lightning protection specialists.

2.1 System components

① Roof connection components

Ground rail type 61

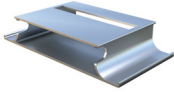

Ground rail base



Assembly post
(PVC, bitumen or
bright stainless
steel)

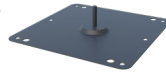

Connector USO S



Ground rail connector

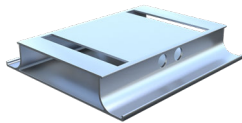

Base Plate



Covering (PVC or
bitumen)



Gravel base plate



② Base

Base

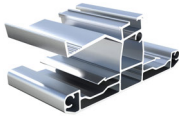

③ Tower

Tower



Tower windshield



④ Roll-bar

Roll-bar



⑤ Splice for roll-bar

Splice for roll-bar

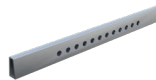

⑥ Windshield

Windshield

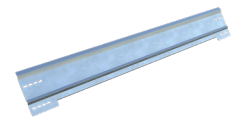

⑦ Cross brace adapter

Cross brace adapter

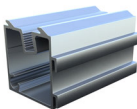

⑧ End clamp

EH AK II Klick 30-50



⑨ Mid clamp

MH AK II Klick 30-50 A



MH AK II Klick 30-50 A grounding plate



⑩ Roof building screws

Roof building screws



⑪ Ballast tray

Ballast tray

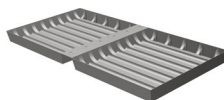

⑫ Ballast block (optional)

Ballast block

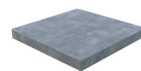

⑬ Covering cable duct

Covering cable duct



⑭ Side panel

Side panel

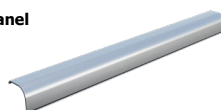

⑮ Clip Windshield

Clip Windshield



2.2 Installation – ground rail



Do not leave the installation site until the ballast for each module has been installed in accordance with the ballast chart. Without the ballast, the stability of the module array is not guaranteed. The correct position of the ballast blocks and building screen mats should be checked as part of the annual maintenance inspection. It is the responsibility of the installing company to check the specification and weight of the required ballast blocks.

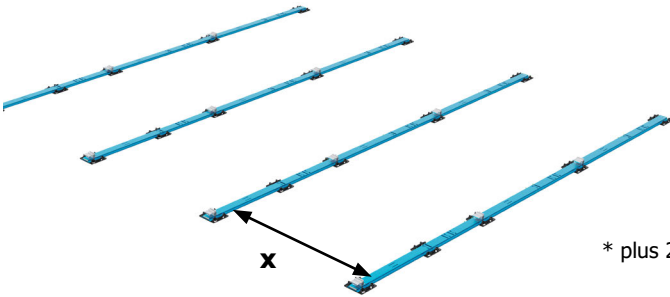

$$x = \text{module length minus } 95 \text{ mm}^*$$

* plus 20mm (width of module holder) minus 115mm (width of ground rail) = minus 95mm

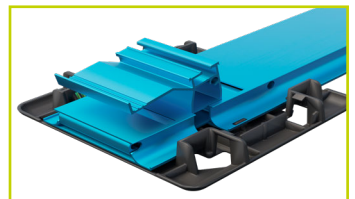
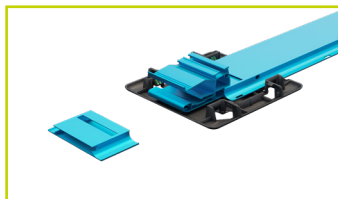
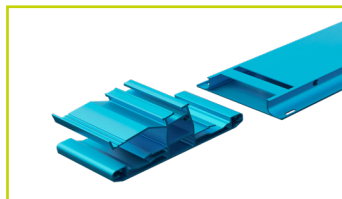
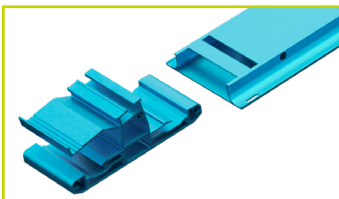

Preparatory work:

Clean the roof surface and clear it of obstructive objects. Measure the roof surface and compare it with planning documents. Draw the system dimensions.

Procedure:

The ground rails are to be laid out one behind the other in accordance with the planning documents. Always start laying out the ground rails on one edge side (east or west side) of the module field. To facilitate alignment of the start of the rails, the side should be selected on which more than one (or all) module rows are flush. The floor rails must be pushed into each other until the click catch engages with an audible noise (see detailed illustration). Check that the latching connection is secure and tight. Place the floor rail on the base plates (assembly template) and click into place. The exact positioning of the base plates can be found in the planning documents or in the cladding plan. The sequence is the same in every row and always ends at the end of the row with a floor rail with base. The floor rail rows must then be aligned with the spacing specified in the planning documents. If necessary, use the assembly gauges for this purpose.



The base must always be positioned with the module installation attachment facing away from the ground rail.

2.3 Installation - Tower and Tower Windshield

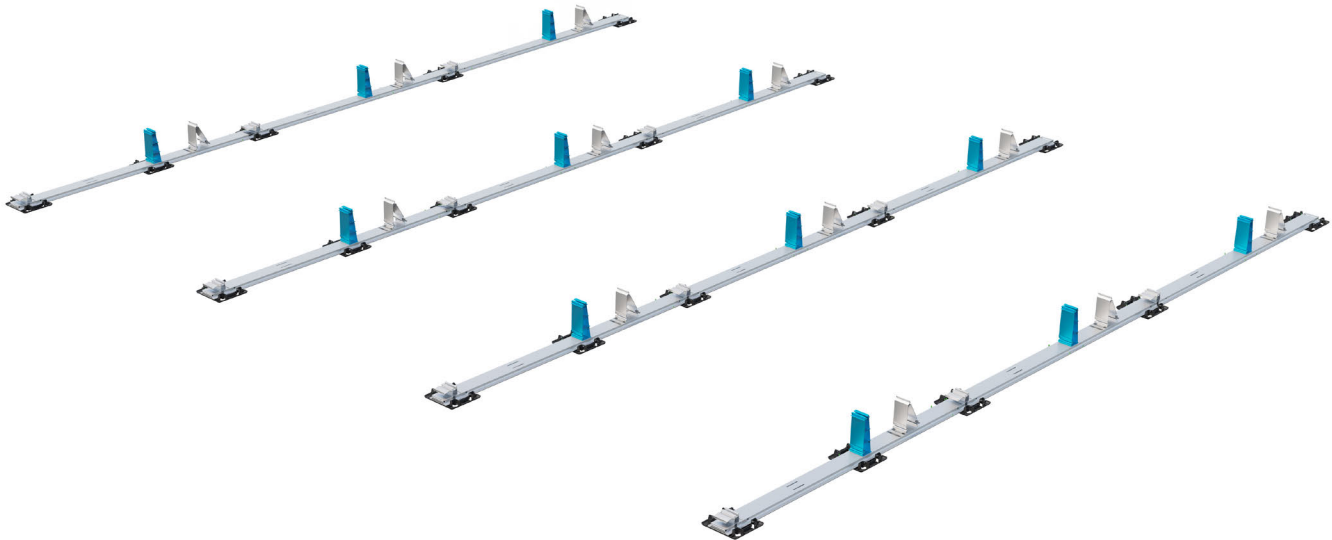

The tower is used as a supporting element for the modules.

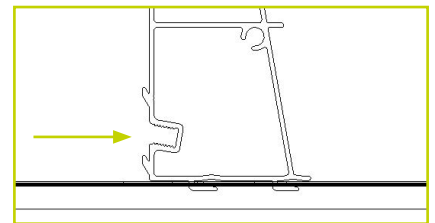
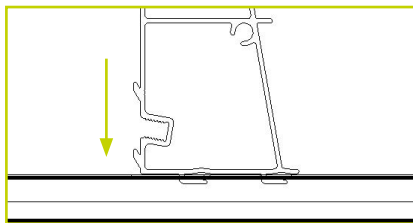
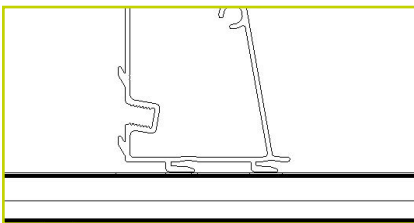

Procedure:

The tower must be inserted into the narrow recesses of the ground rail with both suspension hooks, and pushed sideways until it audibly clicks into place. Check that the click connection is a clean form fit and securely fixed.

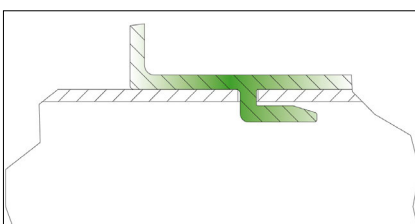

Correct

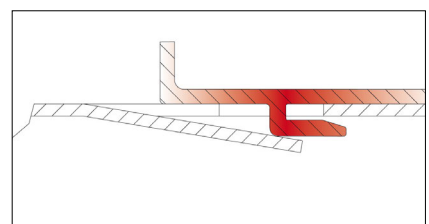

Incorrect

2.4 Installation - roll-bar adapter



The roll-bar adapter is used to attach the cross braces and ballast braces and as an additional screw-on point for side plates.

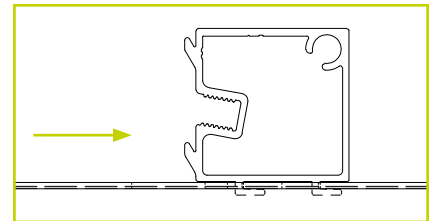
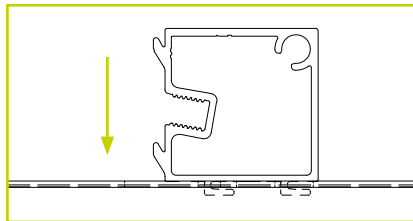
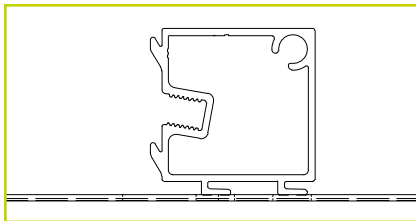

Procedure:

Insert the roll-bar adapter with both hook-in lugs into the two narrow recesses of the ground rail and press it to the side until the click latch engages with an audible noise. The snap-in connection must be checked for proper form fit and strength.

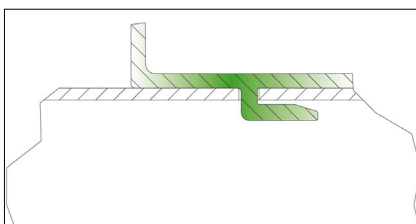

Correct

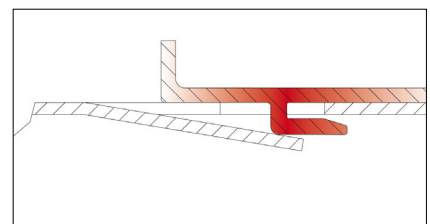

Incorrect

2.5 Installation – roll-bar

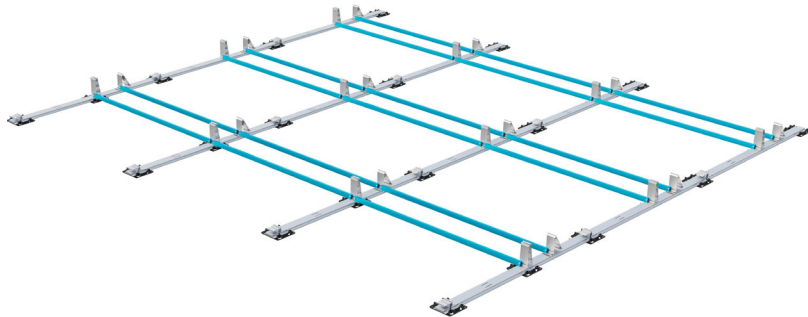

Module length	roll-bar*
1.614 - 1.639 mm	Type 1614
1.640 - 1.665 mm	Type 1648
1.666 - 1.700 mm	Type 1682
1.701 - 1.733 mm	Type 1717
1.734 - 1.776 mm	Type 1752
1.777 - 1.812 mm	Type 1787
1.813 - 1.846 mm	Type 1832
1.847 - 1.879 mm	Type 1865
1.950 - 1.977 mm	Type 1962
1.978 - 2.005 mm	Type 1990
2.006 - 2.033 mm	Type 2017
2.057 - 2.075 mm	Type 2067
2.090 - 2.117 mm	Type 2102
2.118 - 2.144 mm	Type 2130
2.145 - 2.176 mm	Type 2162

The roll-bars have two functions. Firstly, they raise the static part of the system and facilitate further work like placing the cables and positioning the modules, because the ground rails can no longer move out of place. Secondly, they are used to hold additional ballast.

*roll-bar in other lengths on request

Roll-bar at the tower



Roll-bar at the Roll-bar adapter

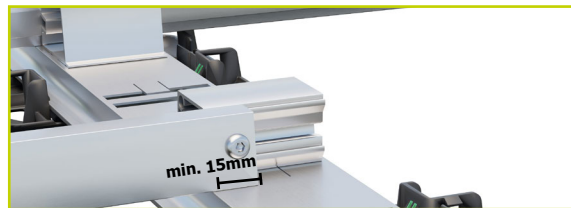
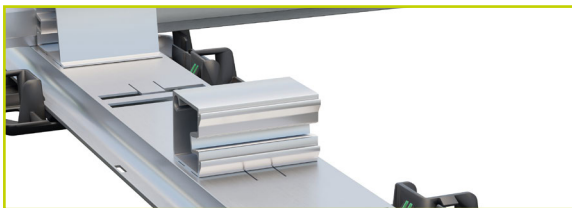

Procedure:

Insert the cross brace on the tower or on the cross brace adapter into the hook-in lugs and screw it in as far as it will go using the ISO 7380 A2 M8x30 screws (tightening torque 8-10 Nm).

Cross brace connector



Procedure:

The cross brace connector must be installed in accordance with the planning documents. This must be inserted into a cross brace up to the centre. The subsequent cross brace must be slid over the cross brace connector and screwed in as far as it will go using the screws ISO 7380 A2 M8x30 screws as far as they will go (tightening torque 8-10 Nm).

2.6 Ballast

In general, additional ballast is required to prevent the PV system from lifting, moving or slipping. The quantity and distribution of the ballast depend on parameters such as location, building height, building surroundings, roofing type and roof pitch. This information is included in the planning documents.



Suitable ballast block dimensions: 40cm x 40cm x 4cm

Option 1 – Ballast Block Type 1

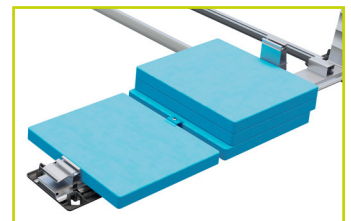
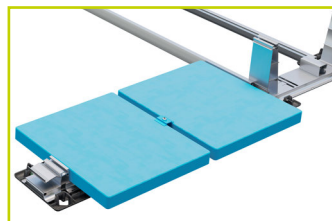
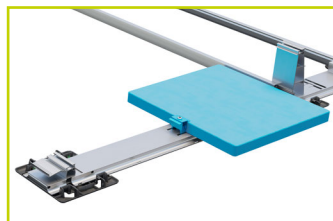
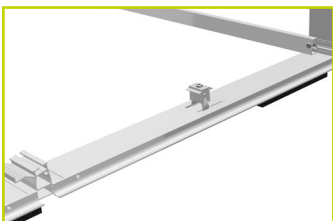
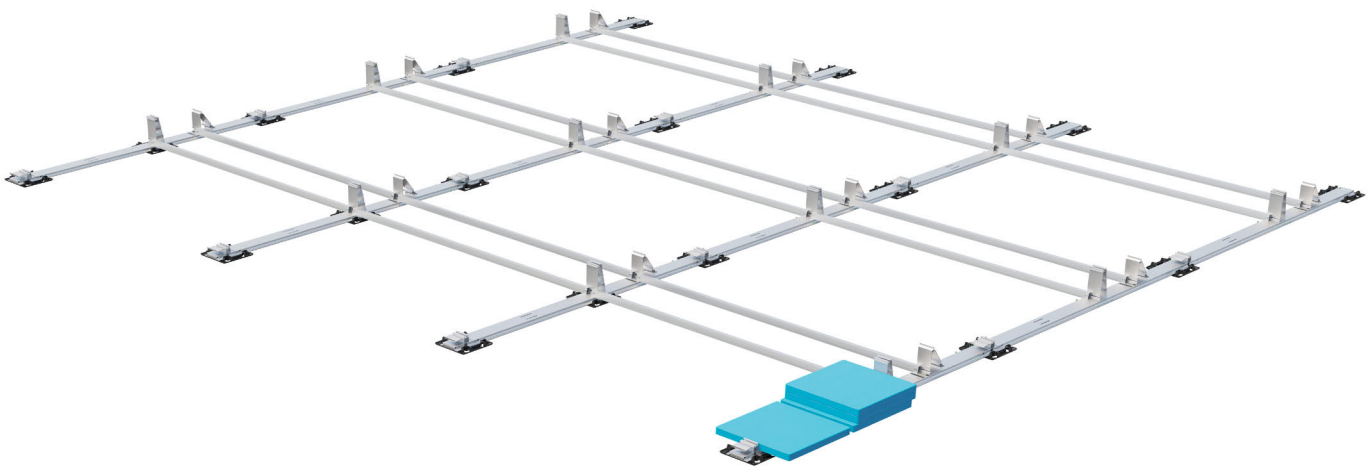

Procedure:

Click the module holder onto the floor rail. Attach the ballast to the floor rail directly on the tower according to the planning documents the tower and fasten it with the module holders. Now adjust the module holder to the height of the ballast and tighten the screw (tightening torque 8-10 Nm).



The position of the ballasting must always be carried out in strict adherence to the planning documents. A different distribution or omission of ballast elements endangers the stability of the entire plant and represents an enormous risk. The position of the ballasting elements must be chosen so that slipping down, tipping or wobbling are prevented. The ballast must lie completely flat. It is insufficient to merely lean the ballast.

Option 2 – Ballast Block Type 2

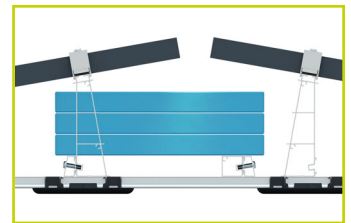
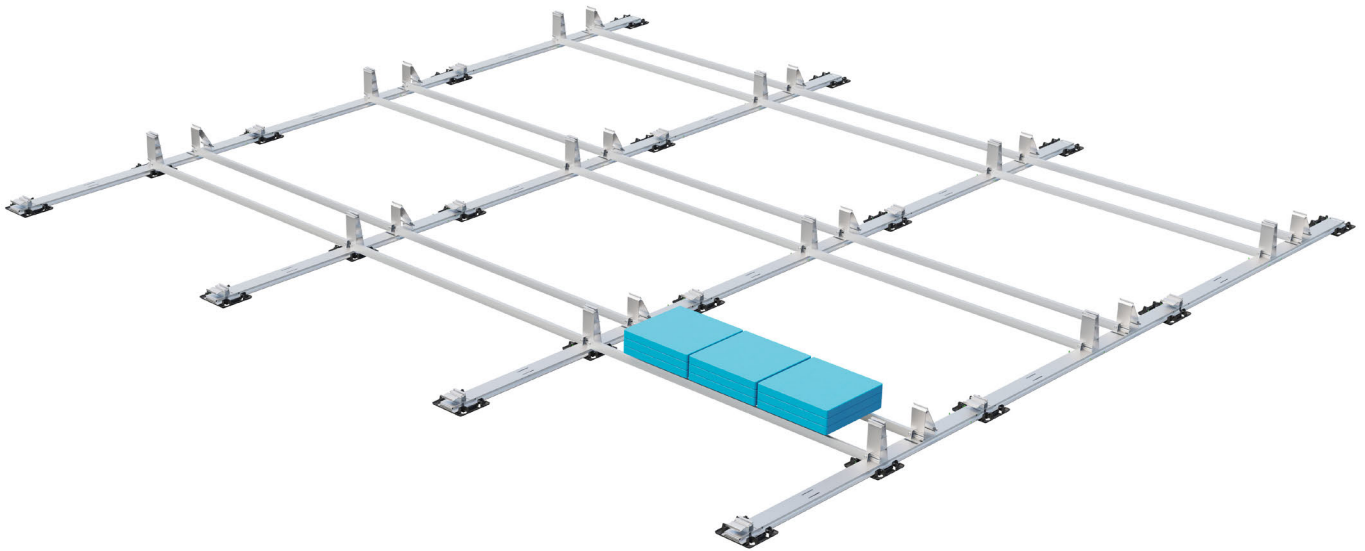
**Procedure:**

Attach the roll-bar on both sides of the tower as described in step 2.5. Position the ballast on the paired roll-bars according to the planning documents (maximum weight per ballast support: 135 kg).



The position of the ballasting must always be carried out in strict adherence to the planning documents. A different distribution or omission of ballast elements endangers the stability of the entire plant and represents an enormous risk. The position of the ballasting elements must be chosen so that slipping down, tipping or wobbling are prevented. The ballast must lie completely flat. It is insufficient to merely lean the ballast.

Option 3 – Ballast Tray

Not all roof surfaces have additional load reserves for the required ballast locations. In particular, roofs with additional ballast such as gravel or substrate are often not able to take on additional loads. In order to use these roofs, ballast trays are used.

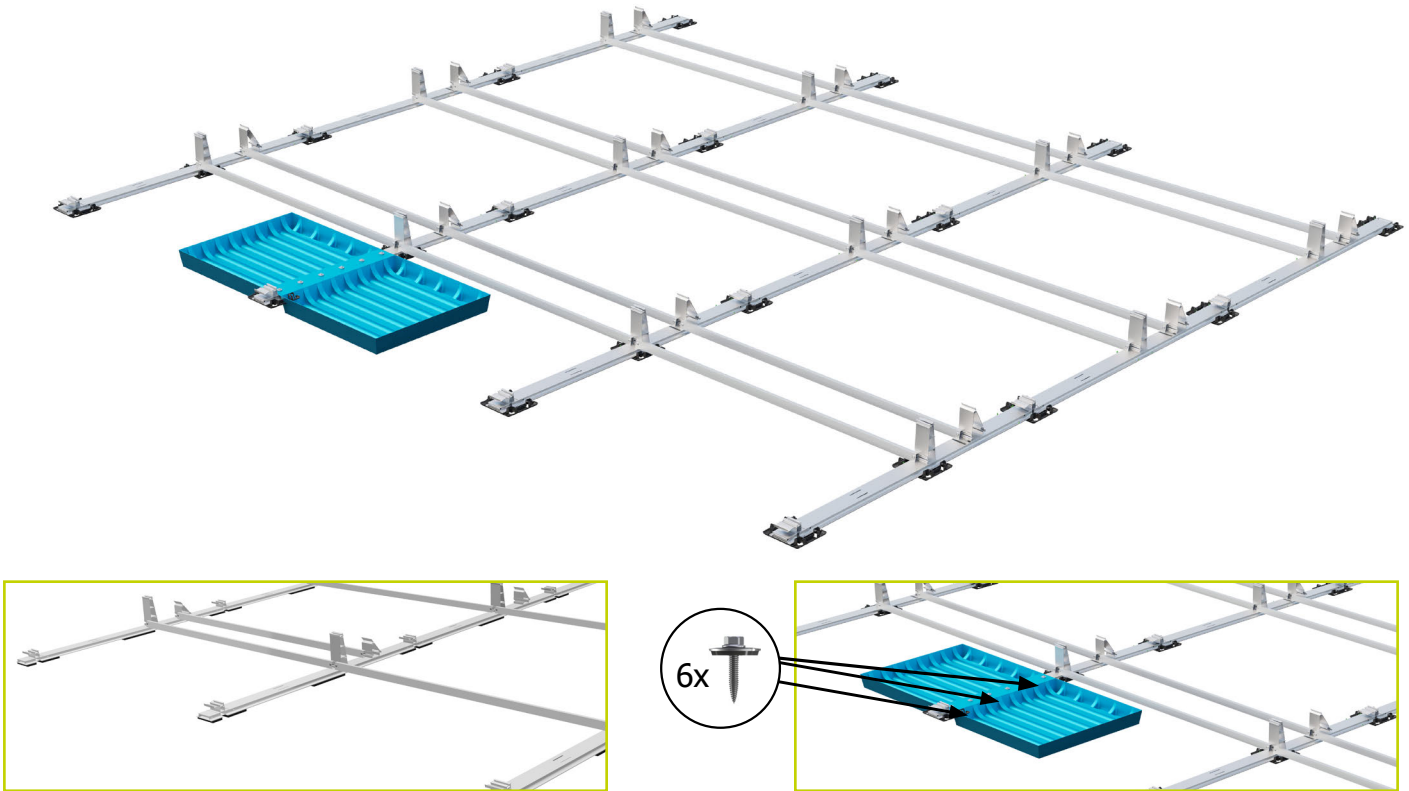

Remove gravel/substrate layer up to the inner edges of the ground rails. The depth of the cleared area over the entire surface should be 50mm from the top edge to guarantee a flat surface for the ballast tray on the remaining layer or roof surface.

If placing the ballast tray directly on the roof covering, ensure that the substrate is clean to avoid long-term damage caused by underlying objects between the ballast tray and the roof skin.

Procedure:

Place the ballast tray centrally on the ground rails between the base and the tower. Align adjacent ballast trays correctly and ensure that the screws are sufficiently attached to the ground rails.

Fasten the ballast tray onto the ground rails using thin sheet metal screws 4.8x19. Use six screws, and ensure that they are centred and evenly distributed (maximum torque 5 Nm). Put ballast back in the ballast tray. Ensure even coverage in the ballast tray.



Ensure minimum coverage in the tray is met according to the planning documents!

2.7 Roof fastening – assembly post

The assembly post offers the possibility of an additional connection of the PV system to the roof substructure. The use of assembly posts extends the mounting possibilities in situations with additional requirements for buildings with low load reserves or high wind loads.

The number and position of the assembly posts can be found in the project report.

The connection to the roof substructure requires roof penetration with up to 6 screws per assembly post. The installation of the assembly posts and the professional sealing of the roof cladding must be carried out by an appropriate specialist (roofing) company.

The assembly posts must be installed as the first step before installing the LEICHTmount RAIL mounting system!

Mounting sequence: Assembly posts → ground rails (see p.12 of these installation instructions)

Prerequisite:

The thickness of the insulation boards / insulation layer must not exceed 120mm.

For trapezoidal steel roofs (UK), the trapezoidal profiles must have a nominal thickness of at least 0.75 mm.

For concrete roofs, the concrete thickness must be at least 100mm.

The assembly post is available in 3 variants:

- With bitumen primer and bitumen covering for flaming (for bitumen roofs)
- With PVC primer and PVC covering for hot-air bonding (for PVC roofs)
- Pure stainless steel, e.g. for processing with liquid plastic (for other roof coverings)

The assembly post is supplied without cleaner, adhesive or liquid plastic for processing. The selection of the processing materials and the compatibility tests with the roof covering are the responsibility of the installer.



The quantity and position of the assembly posts must always be determined in strict adherence to the planning documents. A different distribution or omission of assembly posts endangers the stability of the entire plant and represents an enormous risk.



The installation must be carried out by a specialist company. Improper installation of the assembly posts may lead to damage to the roof covering, moisture entering the roof and permanent damage.

Installation diagram for assembly post on trapezoidal sheet metal (also applies for foil/PVC roof)

Select and mark the position of the assembly post in accordance with the project report. Clean the mounting surface, approx. 60x60 cm (assembly post: 30x30 cm; covering: 50x50 cm).

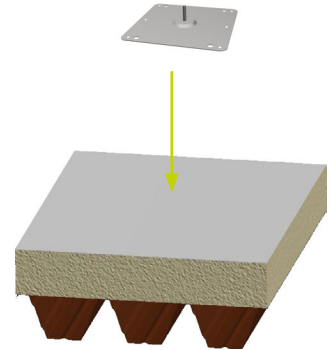

Position the assembly post and screw it into the roof substructure with the appropriate screws OMG HD. The screw connection is established in the raised corrugations of the trapezoidal substructure.

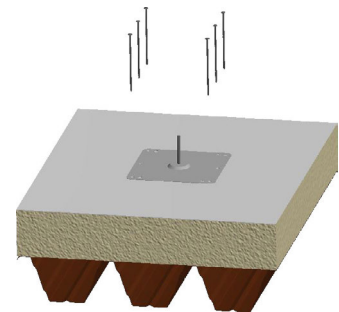

Then place the covering on top and glue it flat to the assembly post and to the roof cladding on all sides.

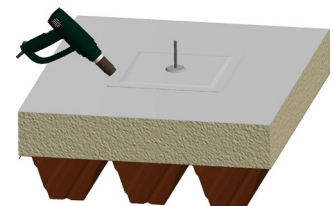
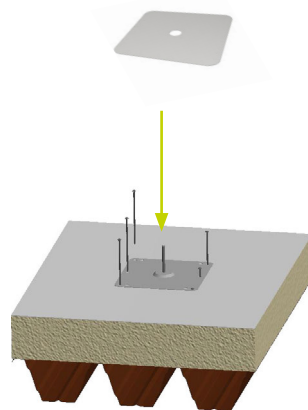

After positioning the assembly posts, the mounting system is set up and connected to the mounting feet in the next step.

This step should be carried out before mounting the module!



For mounting on trapezoidal sheet metal, 6 OMG HD roofing screws (6.7x150mm) are required per mounting foot. The thickness of the insulation layer must not exceed 120mm. The trapezoidal steel profiles must have a nominal sheet thickness of at least 0.75 mm.



For mounting on concrete roofs, 6 OMG HD roofing screws (6.3 mm) are required per mounting foot. The concrete must be at least 100 mm thick. Installation scheme as shown.

The LEICHTmount RAIL S mounting system and the assembly posts are connected via the connector USO S. This is screwed onto the threaded bolt of the assembly post and bolted laterally with 2 roll-bars.

Attachment to the assembly post

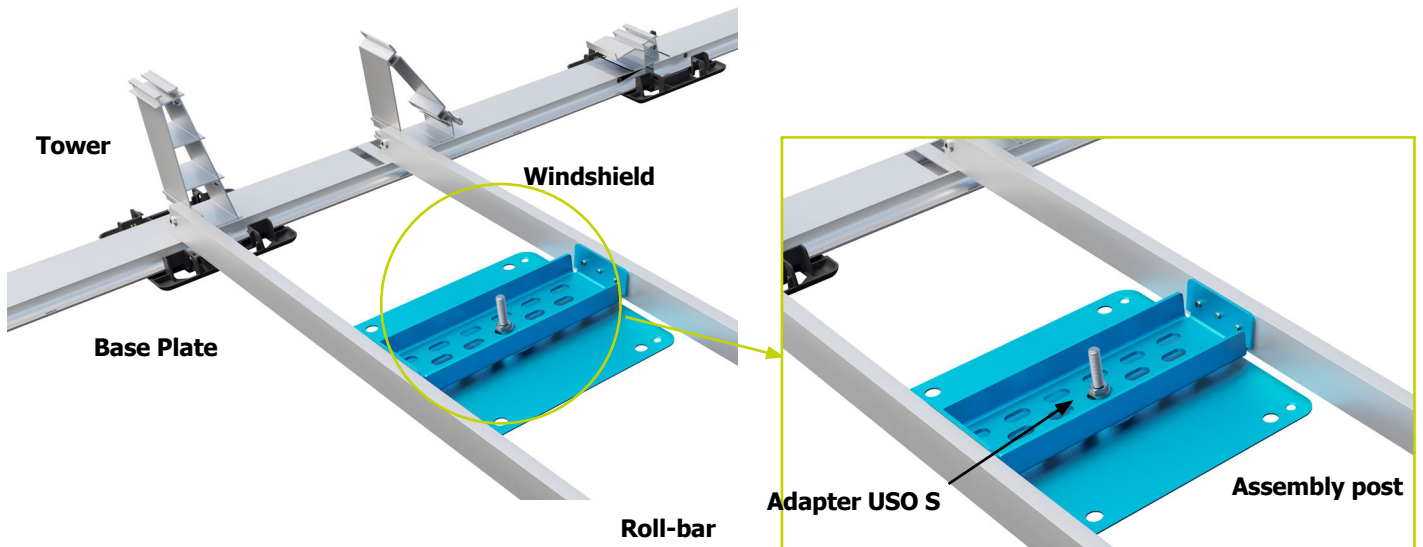

Screw the first M12 locking nut with the flange facing upwards onto the thread of the assembly post and rotate the nut loosely downwards. Place the connector USO S with the round hole onto the thread. Screw the second M12 locking nut with the flange facing downwards onto the thread of the assembly post and rotate the nut loosely downwards. Align the height of the connector USO S to match the roll-bars (upper edges should be flush). The bevelled side of the connector USO S is attached to the roll-bar on the side of the windshield. The connectors USO S are now laterally screwed to the roll-bars with 3 thin sheet metal screws 4.5 x 25 each. Then tighten the M12 locking nuts (tightening torque: 25–30 Nm).

2.8 Module assembly (end clamps)

Place the module on the tower and base. Install the end clamps. To do this, click the end clamp onto the tower and base and push it onto the module. Ensure that the end clamp is clicked onto both sides on the tower and base.

Now adjust the end clamp to match the height of the module and tighten the screw (torque 8-10 Nm). Ensure that the end clamp clamps the module frame at the clamping area defined by the module manufacturer.

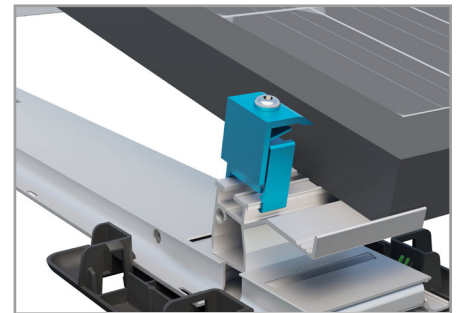
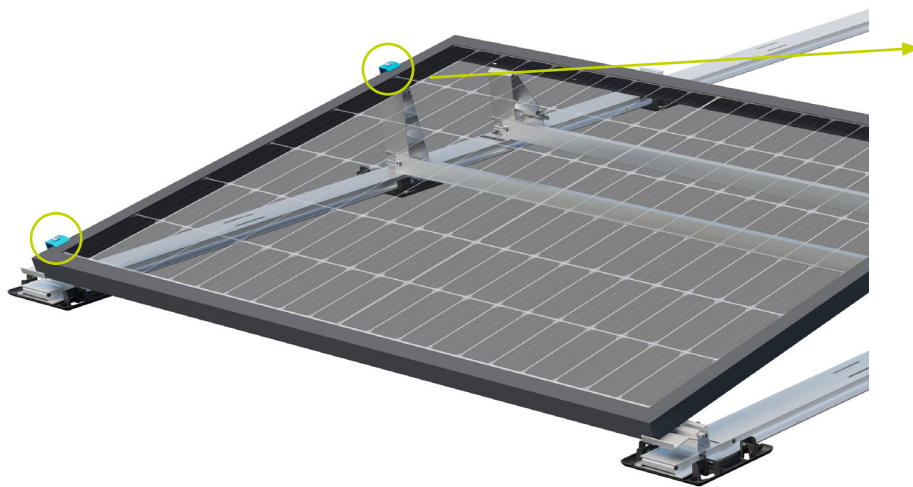

Snap in the end clamp...

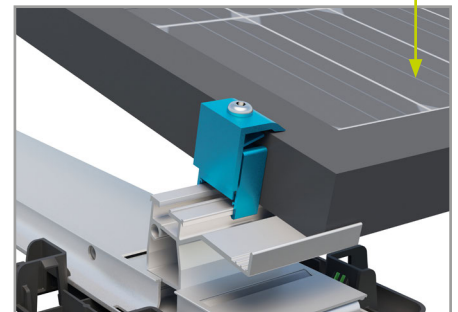

Push in and tighten

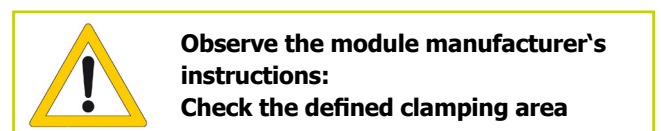
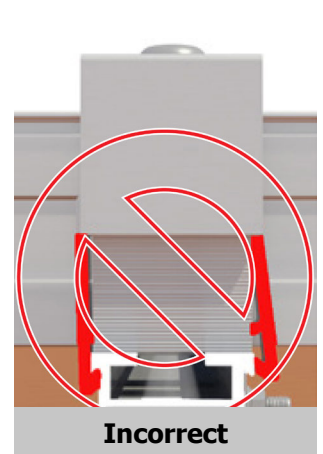
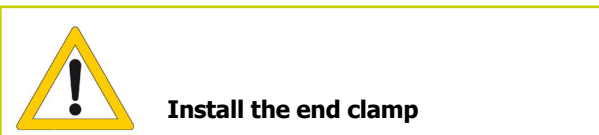

Module assembly (mid clamps)

Now install the mid clamps. To do this, click the mid clamp onto the tower and base and push it onto the module. Ensure that the module mid clamp is clicked onto both sides on the tower and base.



Click mid clamp and push in

Now push the next module under the mid clamp, adjust the mid clamp to the height of the module frame and tighten the screw (torque 8-10 Nm).

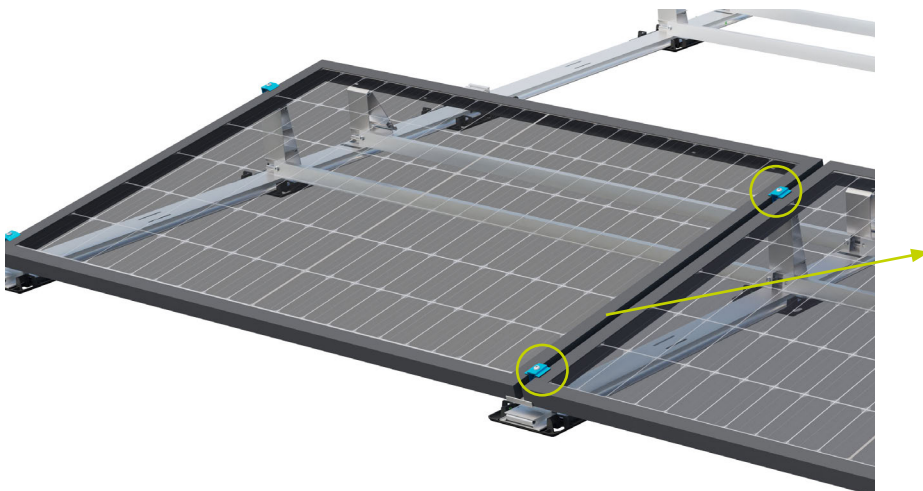

Slide module flush underneath and tighten mid clamp



Ensure that the mid clamp clamps both of the module frames on the clamping area defined by the module manufacturer.

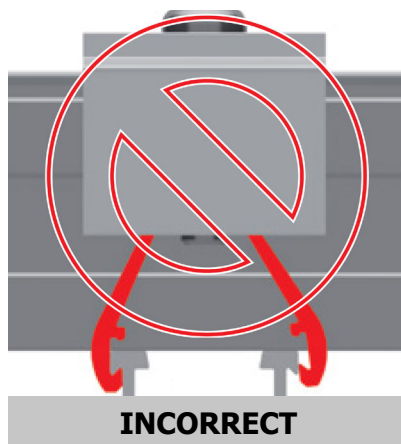
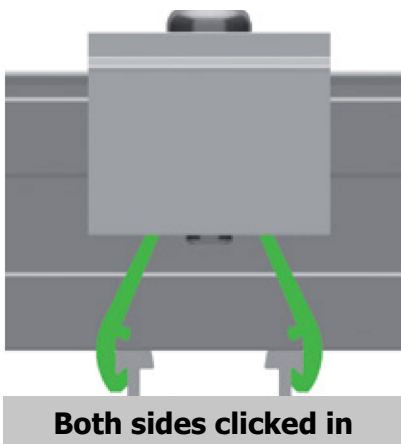
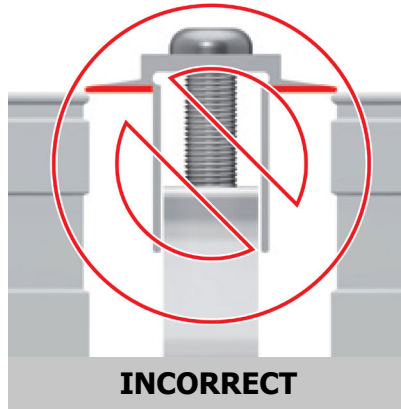
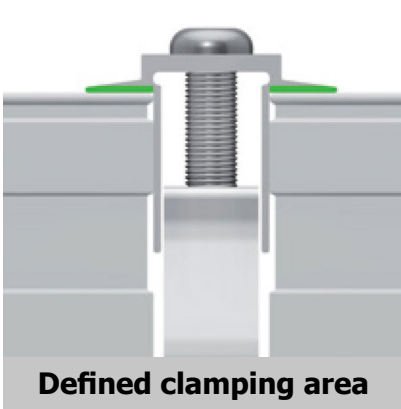

 **Check the module mid clamp has been clicked in**

 **Observe the module manufacturer's instructions:
Check the defined clamping area**

Module assembly (end clamps at the end of the row)

End clamps must be installed on the last module in each row (if applicable, on expansion joints). To do this, click the end clamp onto the tower and base and push it onto the module. Ensure that the end clamp is clicked onto both sides on the tower and base. Now adjust the end clamp to match the height of the module and tighten the screw (torque 8-10 Nm). Ensure that the end clamp clamps the module frame at the clamping area defined by the module manufacturer.

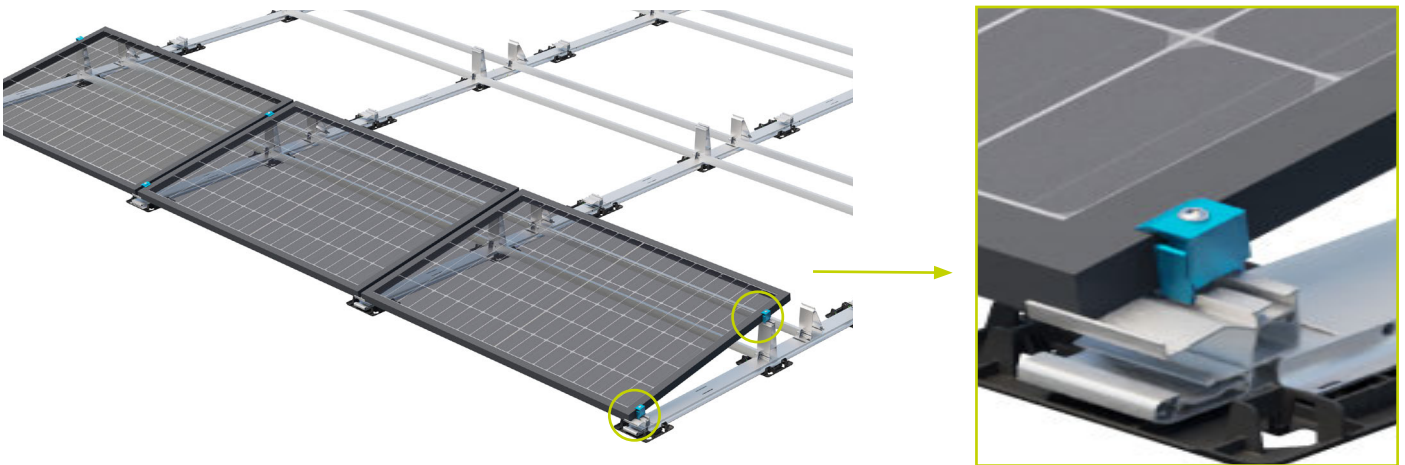

Proceed as described for the following rows.



2.9 Windshield

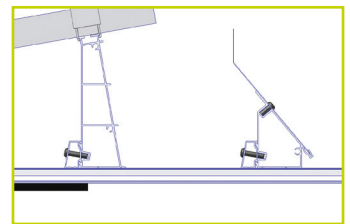
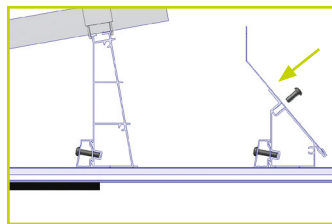
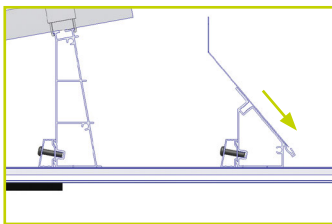
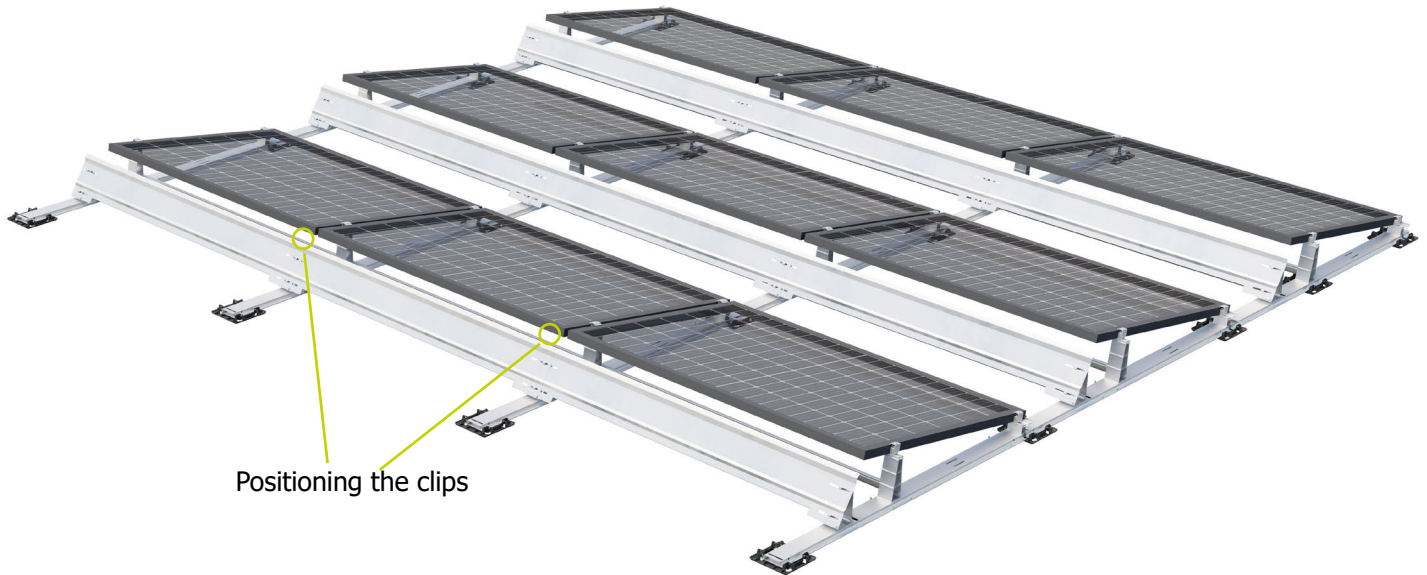

Procedure:

The windshields are suspended in the tower windshield. The windshields overlap in the area of the screw connection (slotted holes). Use one screw per fixing point. Use the ISO 7380 A2 M8x16 flange screw to connect the windshield to the tower (torque 10 Nm).

Windshield clips

In the overlap area, the clips are attached to the upper edge of the windshields. This prevents the plates from rattling in the wind.



The windshield is an aerodynamically system-relevant component and must be installed behind each module. Non-observance of this rule leads to exclusion of any liability!

2.10 Covering cable duct

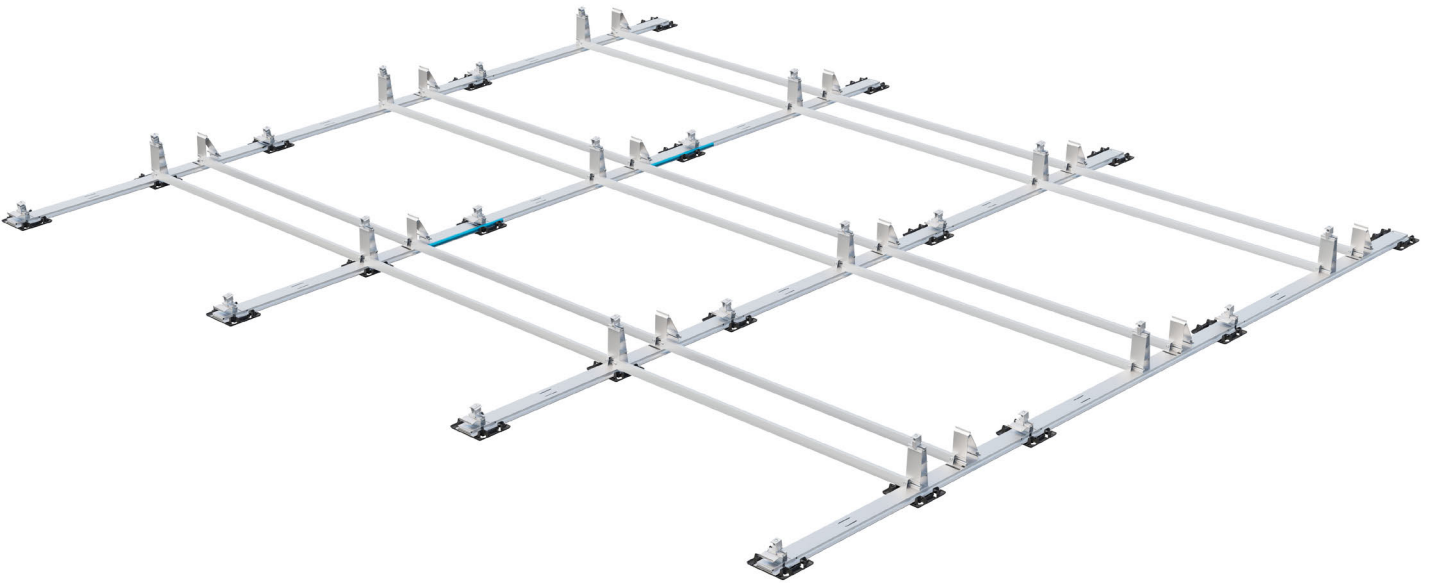

All ground rails have covering cable duct receptacles to protect the string lines from permanent and harmful environmental influences, in particular UV radiation. Installation of the covering cable ducts is possible after every work step of the system installation. The covering cable duct is installed after the cable routing.

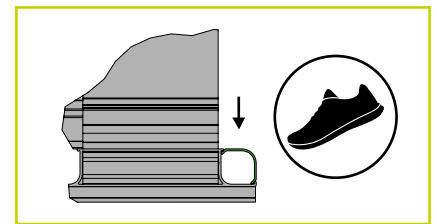
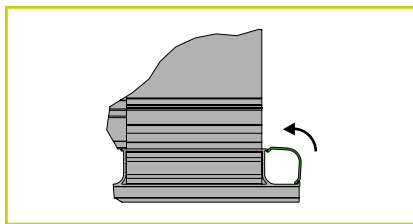
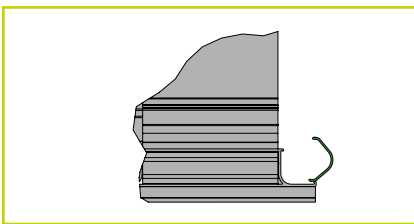

Preparatory work:

Check the clean position of the string lines. Check the permanent and secure fastening of the string lines in order to avoid damage to the lines from movement (wind).

Procedure:

Position the covering cable duct in the lower guide slot on the ground rail. Tilt the covering cable duct upwards onto the top guide slot. Push the covering cable duct in the middle until it clicks into place with an audible click.

2.11 Side panel

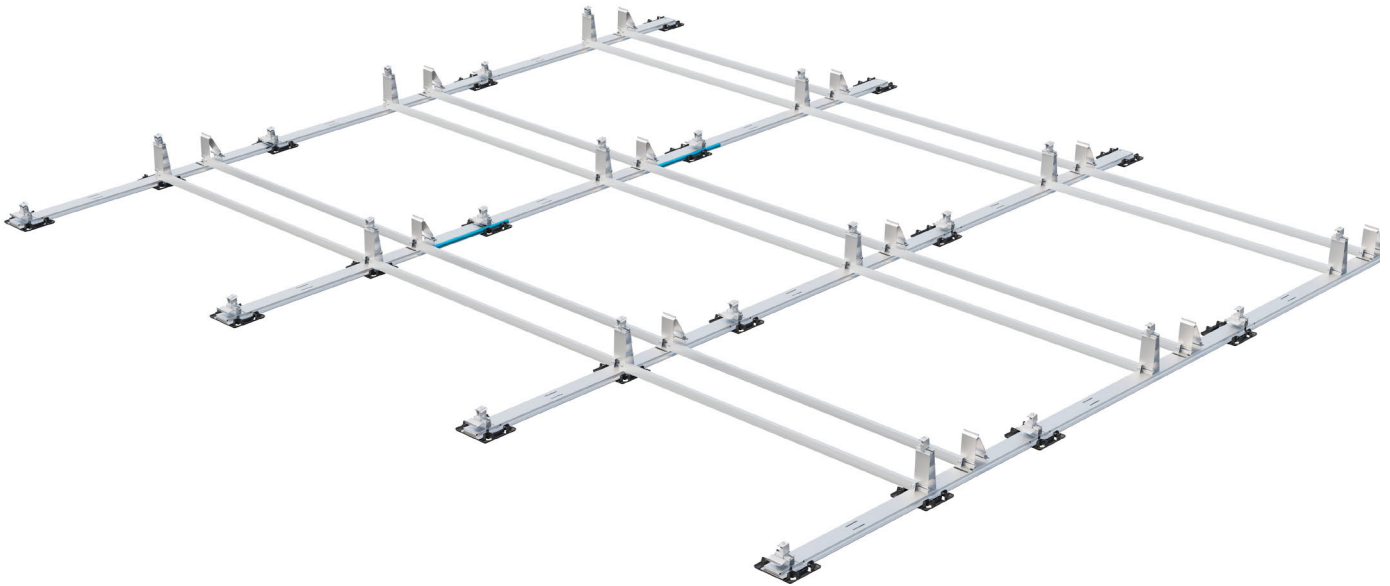

Constructing the system with the side panels improves the cp value, which has a positive impact on the required location ballast, and can also lead to a reduced additional load.

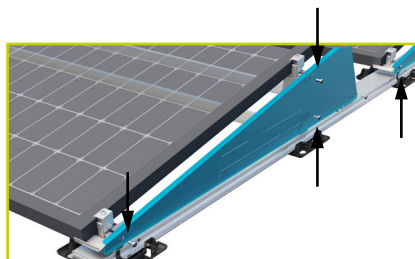
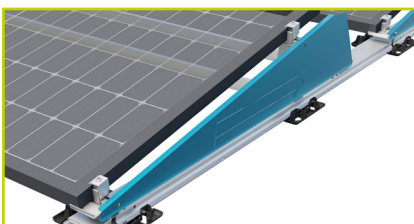

Procedure:

Position the side panels with the screw holes over the screw positions on the tower and base, and fix them using 4 ISO 7380 A2 M8x16 flange screws per side panel (torque 10 Nm).



The side panel is a safety component. The omission of the side panels specified in the project report will inevitably lead to an exclusion of liability of S:FLEX GmbH.

2.12 Final inspection

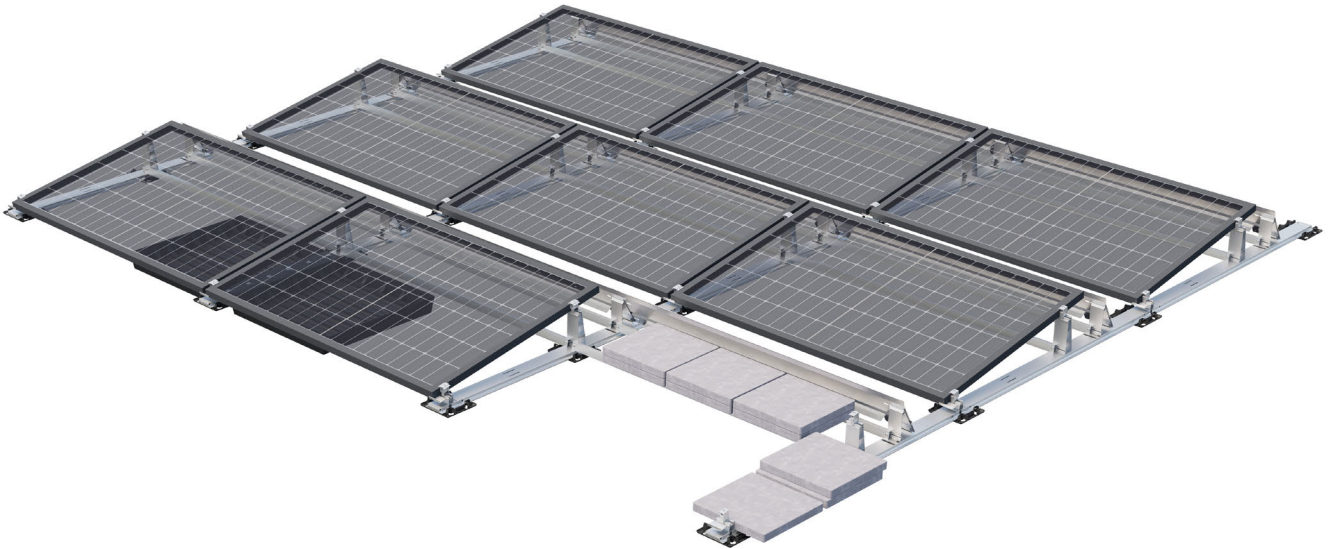

Check whether the entire system and ALL components have been installed according to the planning documents and there are no deviations.

Check whether ALL hexagon socket head screws have been installed in the specified positions (roll-bars).

Check whether ALL screws have been tightened with the torque specified in the installation instructions (module mid clamp, module end clamp, roll-bars).

Check whether ALL ballasts have been attached with sufficient weight according to the planning documents and their condition is durable and secure.



CAUTION! This is important for safety reasons and can lead to considerable damage if not observed!

3.1 Disassembly

Disassembly of the S:FLEX mounting system may only be carried out by trained specialist personnel. Observe the same safety instructions, standards and guidelines as provided for the installation. In general, disassembly is carried out in reverse order to the described installation.



Before disassembly, disconnect the PV modules from the mains network. Disconnect all of the PV modules' electrical cables (string lines and plug connectors) and remove them from the frame system.



Then remove the modules and store them safely. Improper disassembly can lead to damage to the modules.



Disassemble frame system and safely store all of the parts. Any holes in the roof must be sealed by a specialist.

3.2 Disposal

The S:FLEX mounting system is made from aluminium, stainless steel and steel components. These materials can be recycled after disassembly. The frame system must only be disposed of by a specialist waste management company. Observe the applicable national standards and guidelines.

4.1 User agreement for the LEICHTmount RAIL 2.1 S

We point out that the assembly system is sold as part of a purchase agreement.

Its installation/processing or acquisition by a third party is not carried out in the name of, or on behalf of, S:FLEX GmbH. Installation/processing of the system must be carried out by appropriately qualified personnel and strictly in accordance with the installation instructions.

The design and planning of the system must be undertaken using the S:FLEX Planning Software. S:FLEX GmbH is neither responsible for the project-specific structural analysis of the roof structure, nor for obtaining and documenting the approval of the roof manufacturer for use of the respective fastening system on the roof in question (in the terms of the warranty), nor for correct installation of the fastening system.

S:FLEX GmbH accepts no liability for faults and damage and/or a restricted or limited operational capability of the system which has resulted from incorrect installation and/or installation which was not undertaken in accordance with the installation instructions and/or the project report. In the case of incorrect installation, the buyer's right to assert claims for material defects shall expire.

The system warranty is only valid if all system components were acquired from S:FLEX GmbH.

The system requires approval for the modules to also be mounted in the indicated manner (i.e. fitted to the modules' shorter sides). This approval can either be given generally as part of the module certification or, as the case may be, issued by the module manufacturer on a project-specific basis.

4.2 Warranty / disclaimer

The information regarding dimensioning provided in these instructions is merely suggested values based on prior experience. Binding structural analyses for installation frames can be created using the S:FLEX planning software.

As an installation company, you are responsible for the correct execution of the installation. S:FLEX GmbH is not liable for the dimensional information contained in commercial system quotations.

As an installation company, you are responsible for the mechanical durability of the interface connections mounted on the building's structure. In particular, this includes ensuring that these are leak-tight. The components supplied by the company S:FLEX GmbH are designed for the expected loads and in accordance with the currently available technology. In this context, you must provide the company S:FLEX GmbH with information about all general technical conditions in writing via the project data collection sheet (information about the supporting structure, snow load zone, building heights, wind loads, etc.).

S:FLEX GmbH is not liable if the installed components are not properly handled. Any use close to the sea needs to be clarified with S:FLEX GmbH directly on a case-by-case basis due to the increased risk of corrosion. Provided that the system is handled properly and dimensioned according to the structural conditions and normal environmental and ambient conditions, the company S:FLEX GmbH provides a warranty from transfer of risk to the warranty holder, which guarantees that the metallic components of the racks will remain free from defects with regard to material and workmanship for a period of 10 years. This warranty does not apply to wear parts. For additional information, please refer to the separate warranty provisions.

This applies within the context of the generally prevalent weather and environmental conditions.